



S-Pixie QRP Kit

User Manual

Revision V160515

Welcome to visit the home page www.lxggfy.com to obtain the latest data.

1. Introduction

“PIXIE” is a very small volume of simple 40 meter band micro-power amplitude telegraph transceiver, Despite it's small size and DC receiver limitations, it is capable of working several hundred miles when connected to a good 40 meter antenna.

"S-Forty-9er", Designed by “**LXQQFY.com**”,. Improvements are as follows:

- The vertical resistance is changed to horizontal resistance, Solves the problem of resistance to short circuit.
- We do not distinguish between positive and negative electrodes of power supply. Power input range increased to 13.8V.
- Add the buzzer sounds for send (use jumper shield), Add led signal for send.
- Add acrylic shell.

2. Specifications

Power supply: 9~13.8V Volts DC, >500mA (Recommend the use of batteries)

Antenna: 50ohm,7MHz,SWR<2.0

Receive: static current 20mA

Transmission power: 1.2W

Frequency: launch the vibration frequency,7023 KHZ

Receives the local oscillator frequency: about

7023-7023 KHZ work mode: the CW

KEY: Manual

Case: Acrylic

3. Circuit principle

See the last page of the document accompanying drawings, 9018 and surrounding components constituting a typical Colpitts oscillator and keeps oscillating (the oscillation signal leaks around 1mW) when receiving the local oscillator signal is directly coupled through a capacitor to 8050. Emission state (the key is pressed), 8050 as a class C amplifier, the amplified signal via 0.01uF capacitor coupled to a pi-type low-pass filter, and then sent to the antenna; reception state (key release), 9018 element around the beat oscillator (BFO), 1N4001 coupled with high voltage and reduce capacitive pressure is increased with the ends of the DC, the local oscillation frequency can be increased to approximately 0-3KHz 7.023MHz reception signal can be easily carried out bats frequency. 8050 is biased in the non-linear region (think transistor is nothing more than two back-to-back second diode incorrect), the signal received by the antenna with the BFO signal mixer, mixing the audio signal obtained after the 0.1uF capacitor coupling posed to the LM386 audio power amplifier, the audio signal amplified by the 10uF capacitor across the LM386 5 feet straight evacuation headphones. The key control not only the LM386-off of the power supply is switched 1N4001 varactor bias, so that the capacity of the type of state change.

4. Production process

4.1 According to the list of components, check the number of components. Have tools, Electric iron, Solder wire, and A multimeter on hand. Take welding from low to high order, Recommend: Resistance -> Diode -> Capacitance -> Triode -> Crystal oscillator -> Bridge rectifier -> Electrolytic capacitor -> Ic -> Inductor -> LED -> Other.



4.2 Resistance.

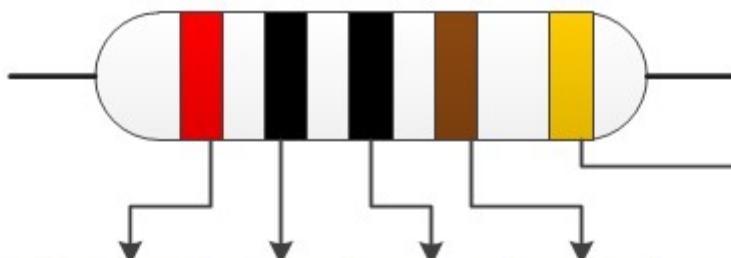

颜色	百位	十位	个位	倍数	精度
黑	0	0	0	1	
棕	1	1	1	10^1	±1%
红	2	2	2	10^2	±2%
橙	3	3	3	10^3	
黄	4	4	4	10^4	
绿	5	5	5	10^5	±0.5%
蓝	6	6	6	10^6	±0.25%
紫	7	7	7	10^7	±0.1%
灰	8	8	8	10^8	±0.05%
白	9	9	9	10^9	±50%
金				10^{-1}	±5%
银				10^{-2}	±10%
透明					±20%

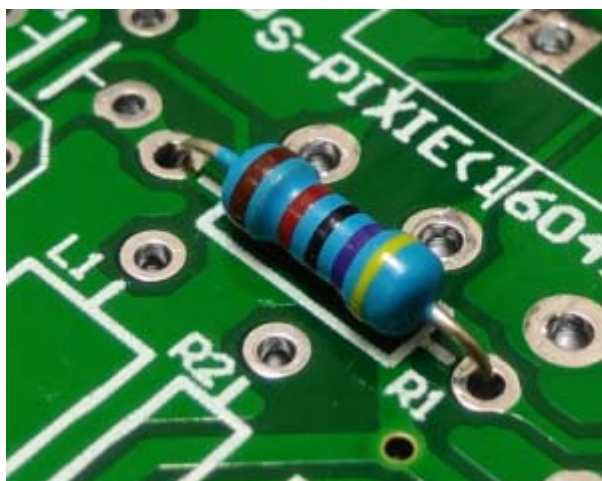

4.3 Diode.



1N4001



1N4148

4.4 Capacitance.

104: 0.1uF 103: 10nF 101: 100pF 471: 470pF 473: 47nF

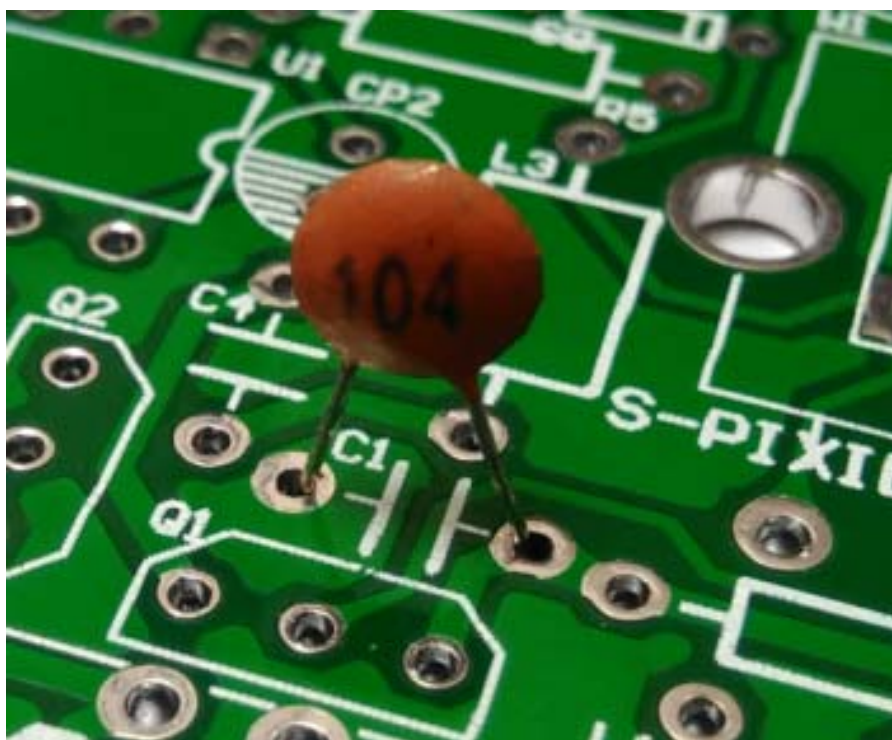

4.5 Triode and FET.



4.6 Crystal oscillator.

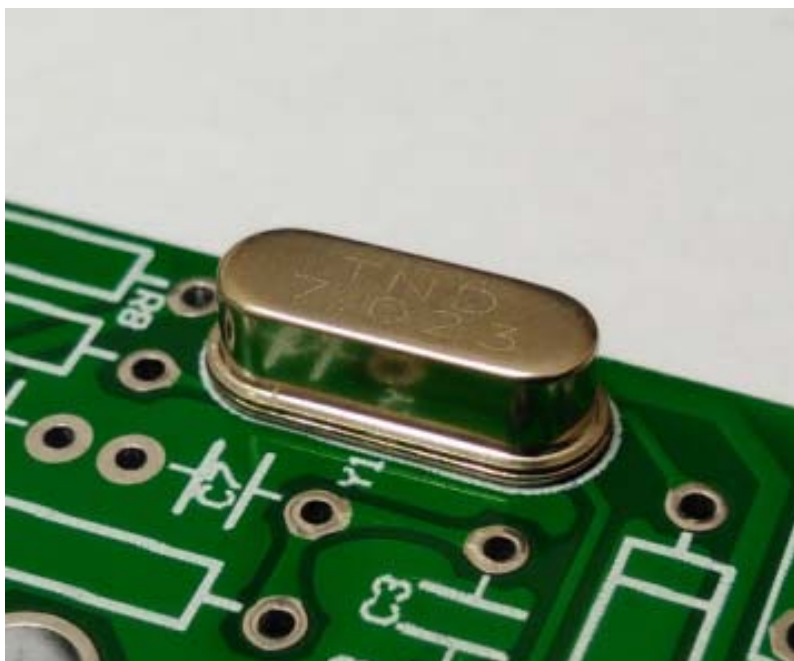

4.7 Bridge rectifier.



4.8 Electrolytic capacitor.

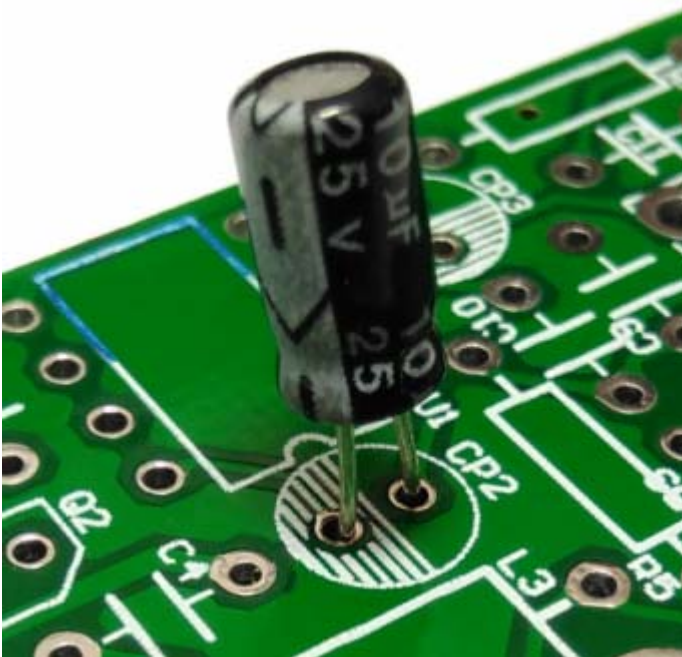

4.9 Ic.

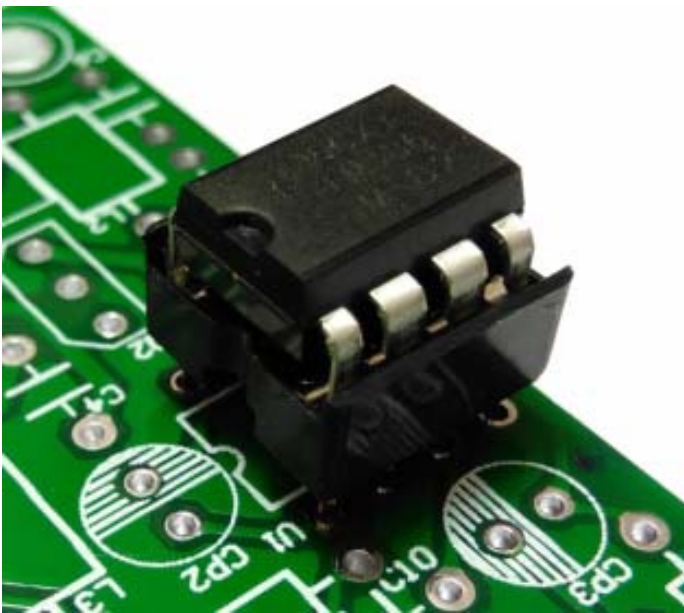

4.10 Inductance.

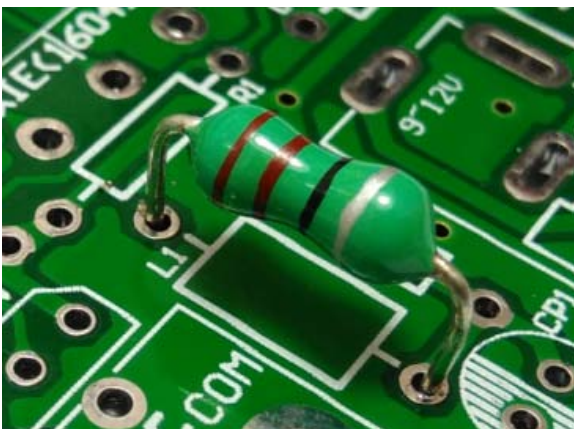

4.11 LED.

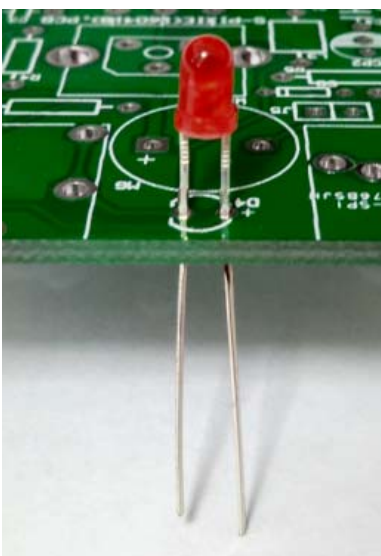

4.12 Other.



DC Jack

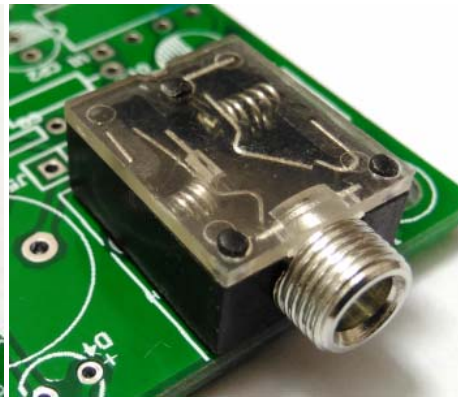

3.5mm Socket(Key and Phone)



Buzzer



Variable resistor

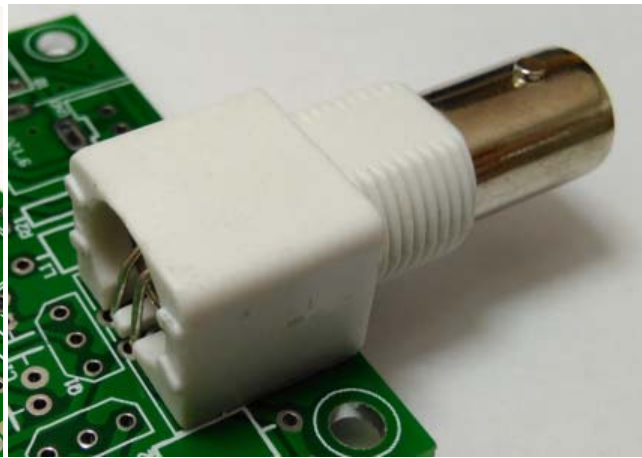

Q9(BNC)



Pin

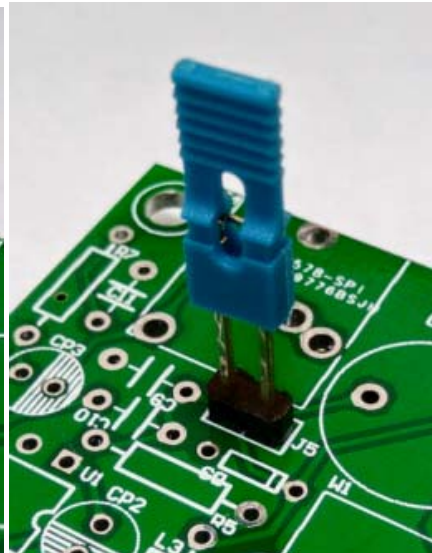

Jumper Cap

4.13 Install the acrylic case.

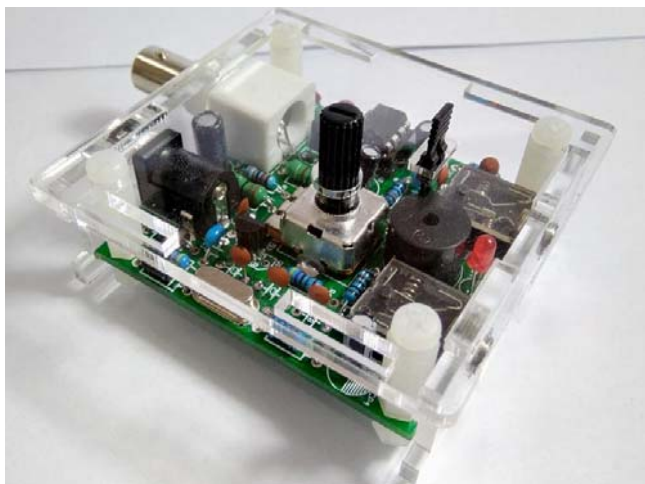
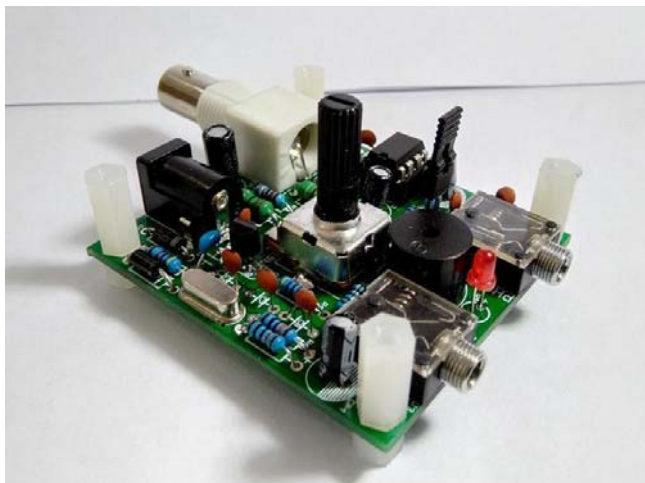

5. Debug

5.1 The power before installation of dummy load.

Method 1:

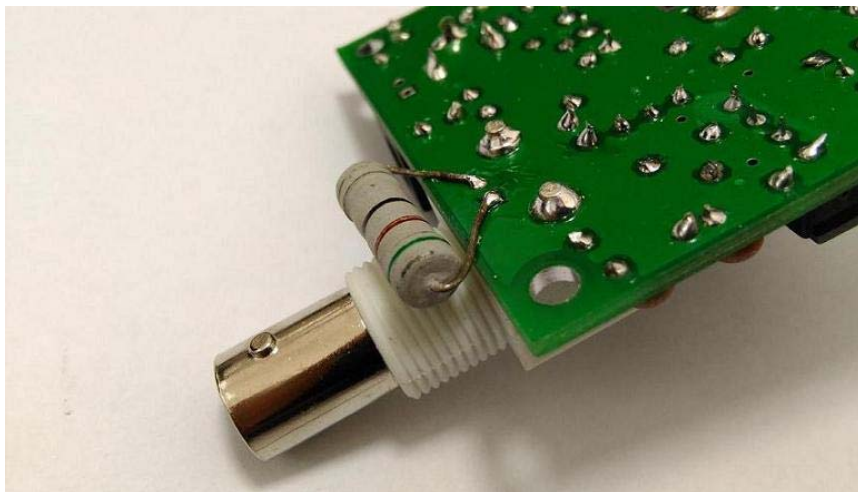

Method 2:



Method 3:



5.2 Power on: **Do not distinguish between positive electrode and negative electrode(Internal rectification)**, Recommend the use of 12V DC battery, Can also use the 12V DC linear voltage stabilized power supply. If power on after tens of seconds without abnormal heating,then it's normal.

5.3 Listen to the base noise: Connect the 8ohm headset, after power will hear a slight voice, then it's normal.

5.4 The receiving circuit test: If connect the antenna to hear the voice and do not connect the antenna to hear the voice of a great difference,then it's normal.

5.5 The sending circuit test: Connect dummy load, connect the key, and power on. Now you can use the key control to send, Static current:20mA, Sending current:120mA, In the sending state under the virtual load will be fever. **Note: it is not a long time to send.**

6. Usage method

6.1 Function diagram

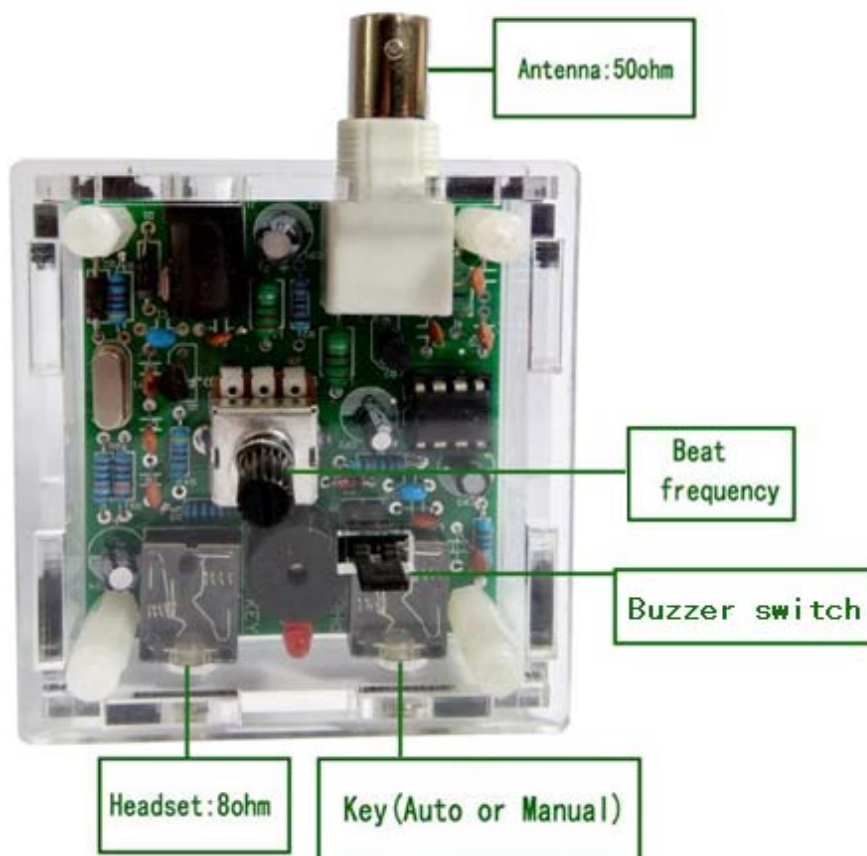

6.2 Key.

Manual-Key Wiring diagram



6.3 Using the most common 8ohm headset.

6.4 The antenna is the key of the shortwave station, Requirements: frequency 7MHz, impedance 50ohm, SWR <1.5. Recommend the following:

6.3.1 GP Antenna.

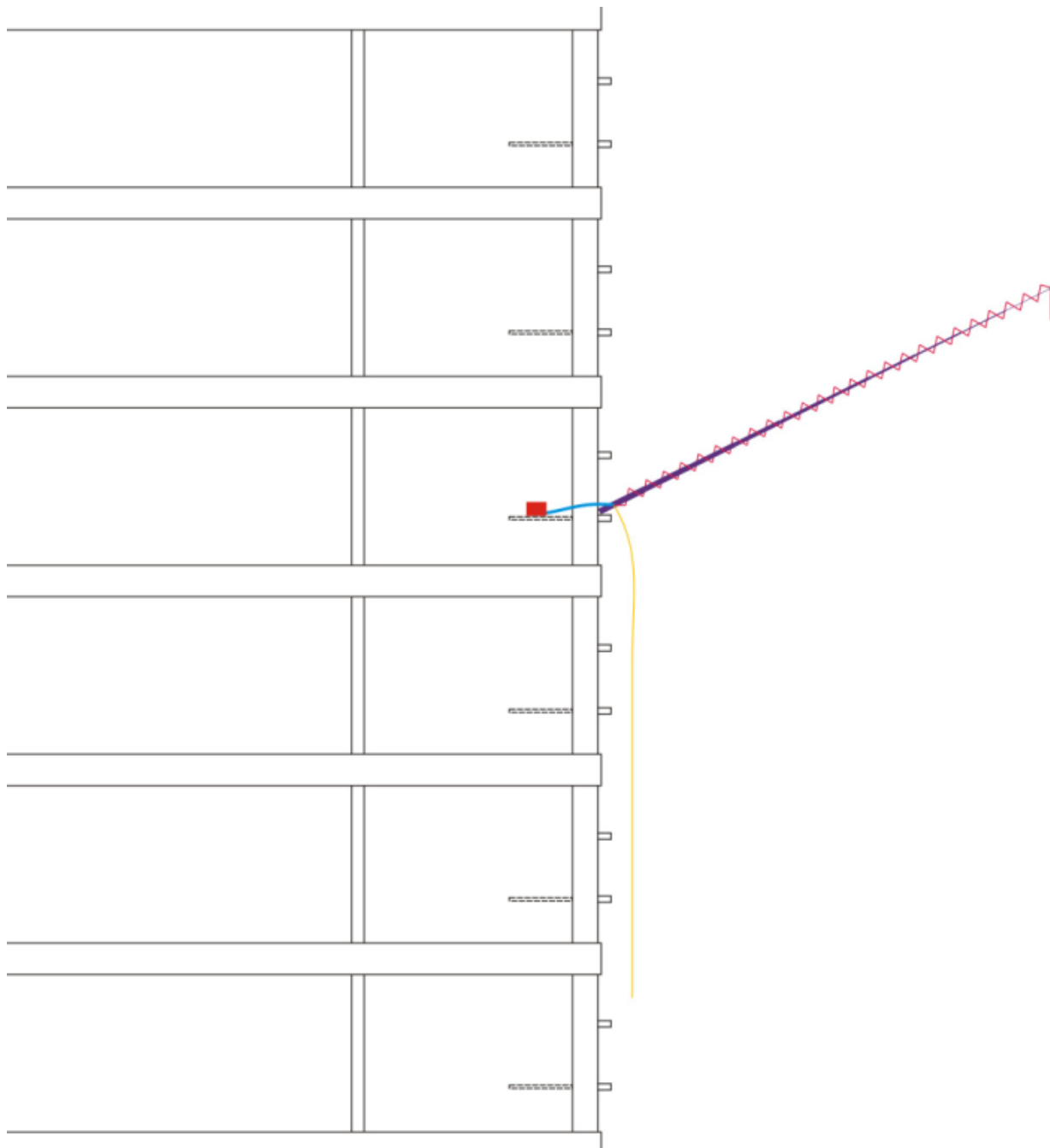

Red: Radio; Blue: Feeder(50ohm); Violet: Fishing rod(9 meters); Yellow: Dummy grounds(9 meters); Pink: Oscillator(10.1 meters);

6.3.1 Windom Antenna.

Winton antenna can be good to work in the three 40m/20m/10m band, the use of 1:4 Balun, according to the actual environment can have a variety of different installation methods.

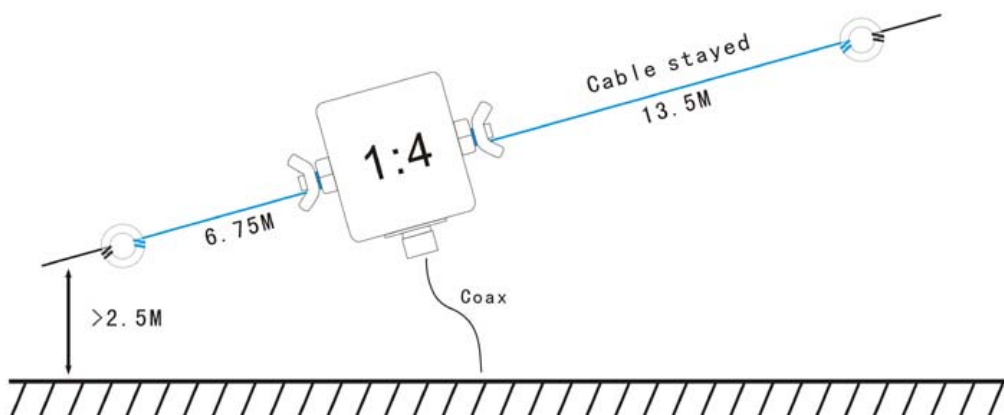
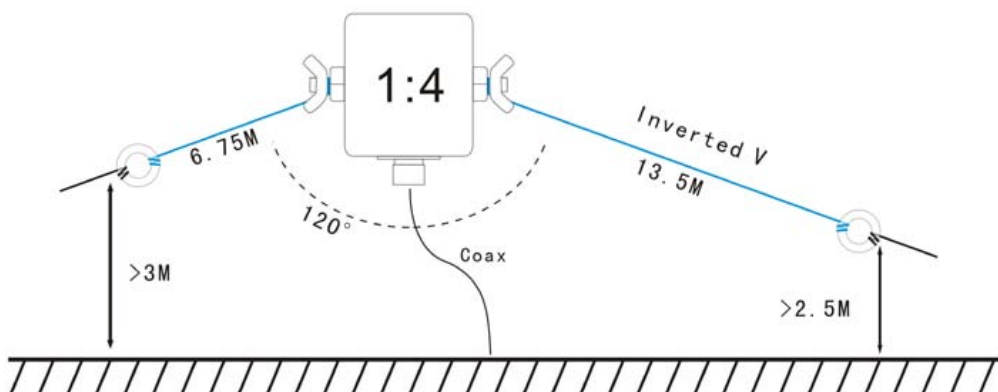
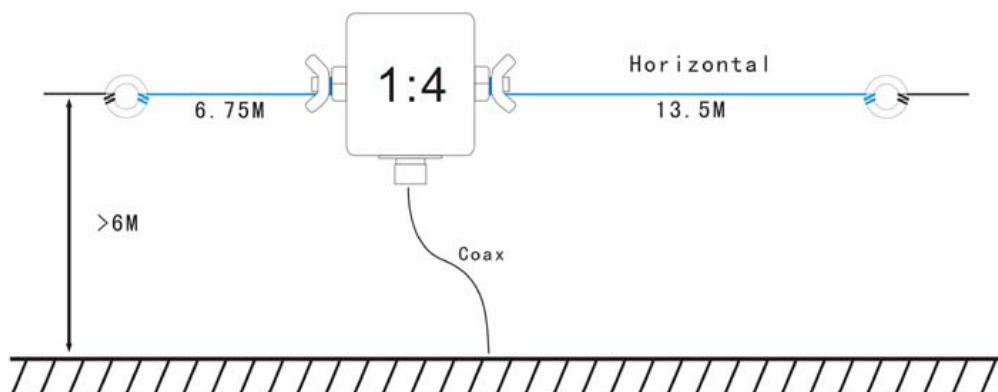

6.3.1 DP Antenna.

The DP antenna is adopted skywave communication, long distance communication effect is very good, the use to 1:1 balun, usually V installation.

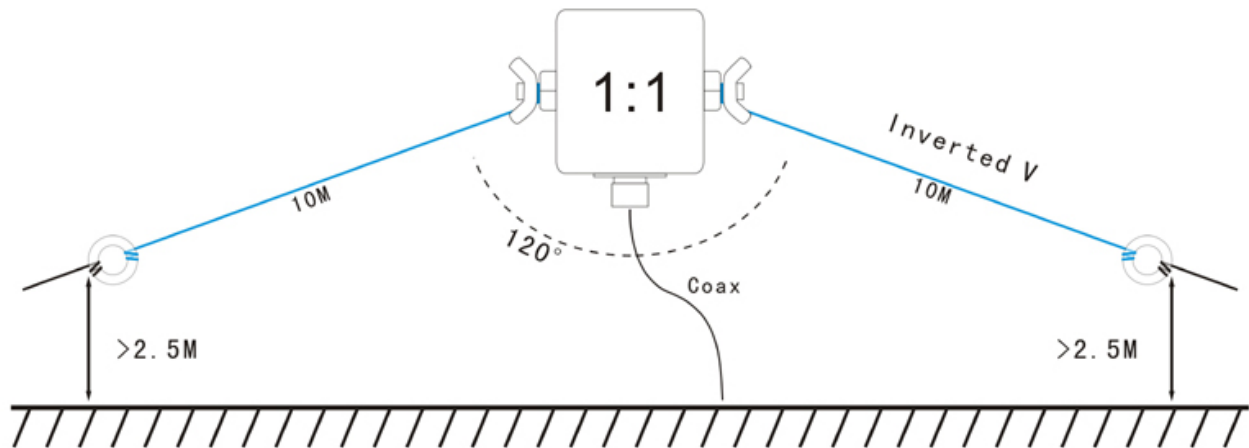

7 Configuration. There are a variety of configurations, this paper shows the highest configuration

7.1 The 2.54 connector, no buzzer, no LED, small Variable resistor, no Acrylic.

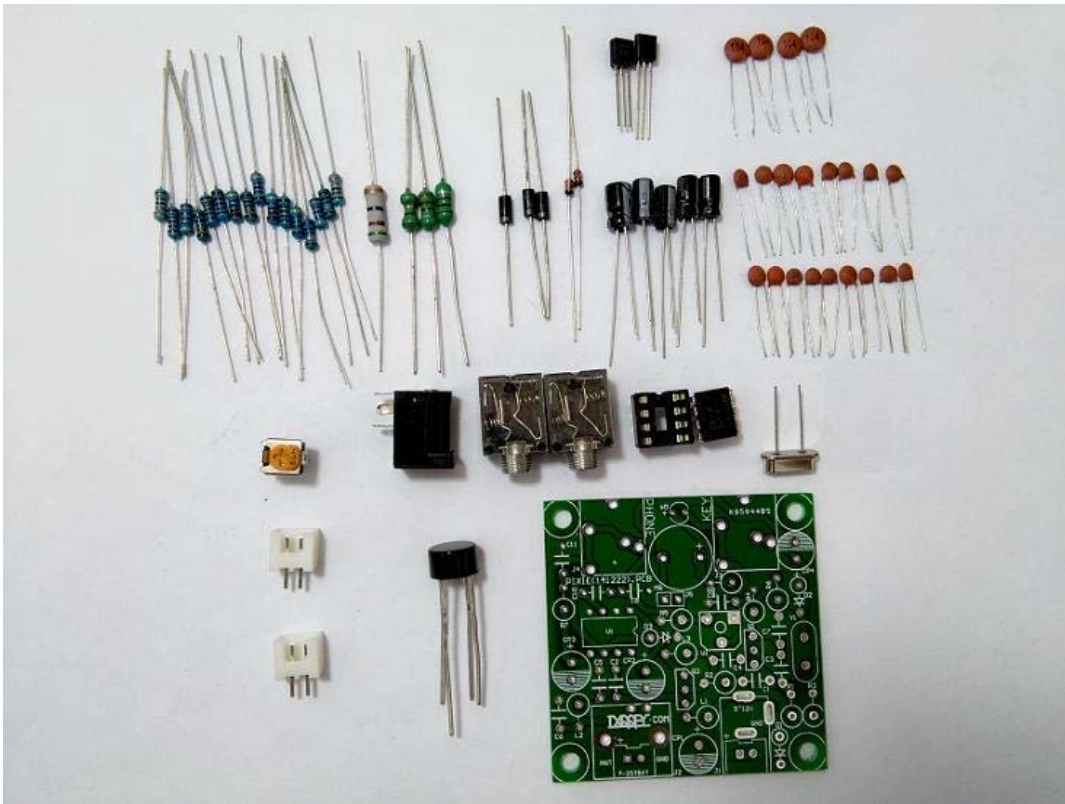

7.2 The 2.54 connector, buzzer, LED, small Variable resistor, no Acrylic.

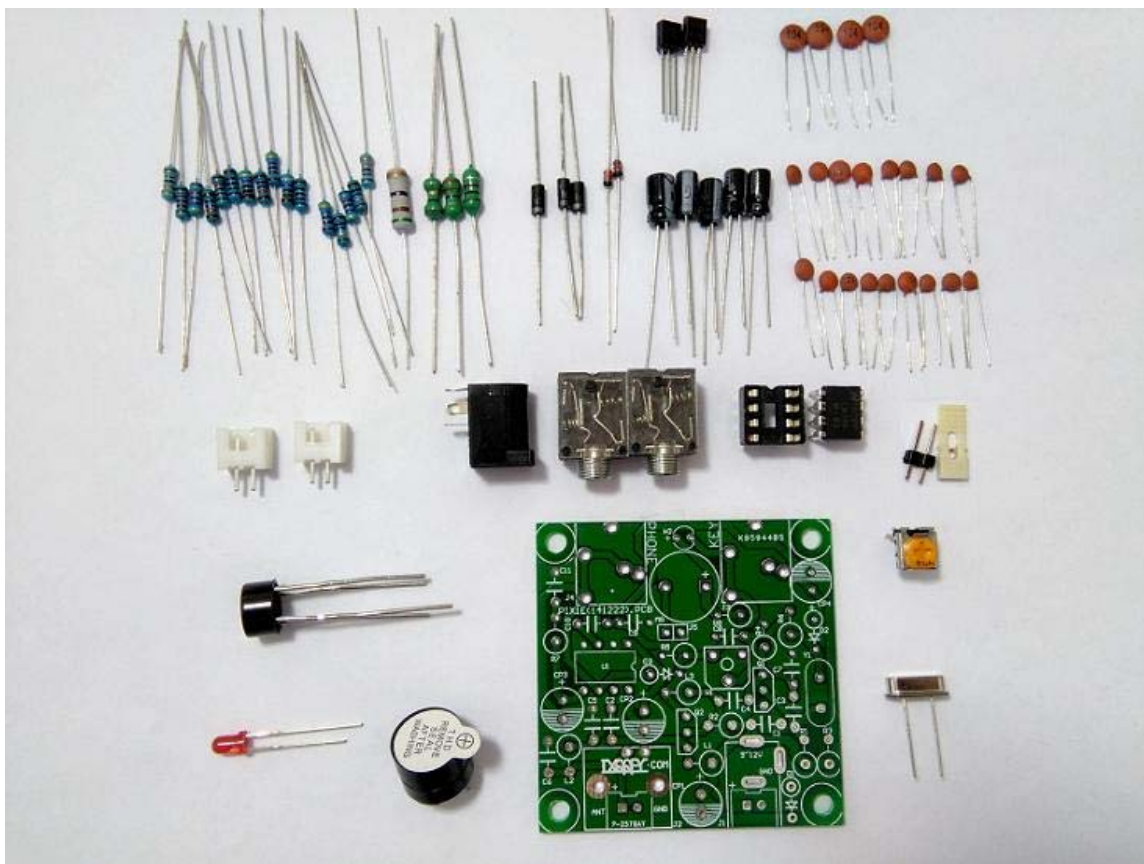

7.3 Q9(BNC), no buzzer, no LED, small Variable resistor, no Acrylic.

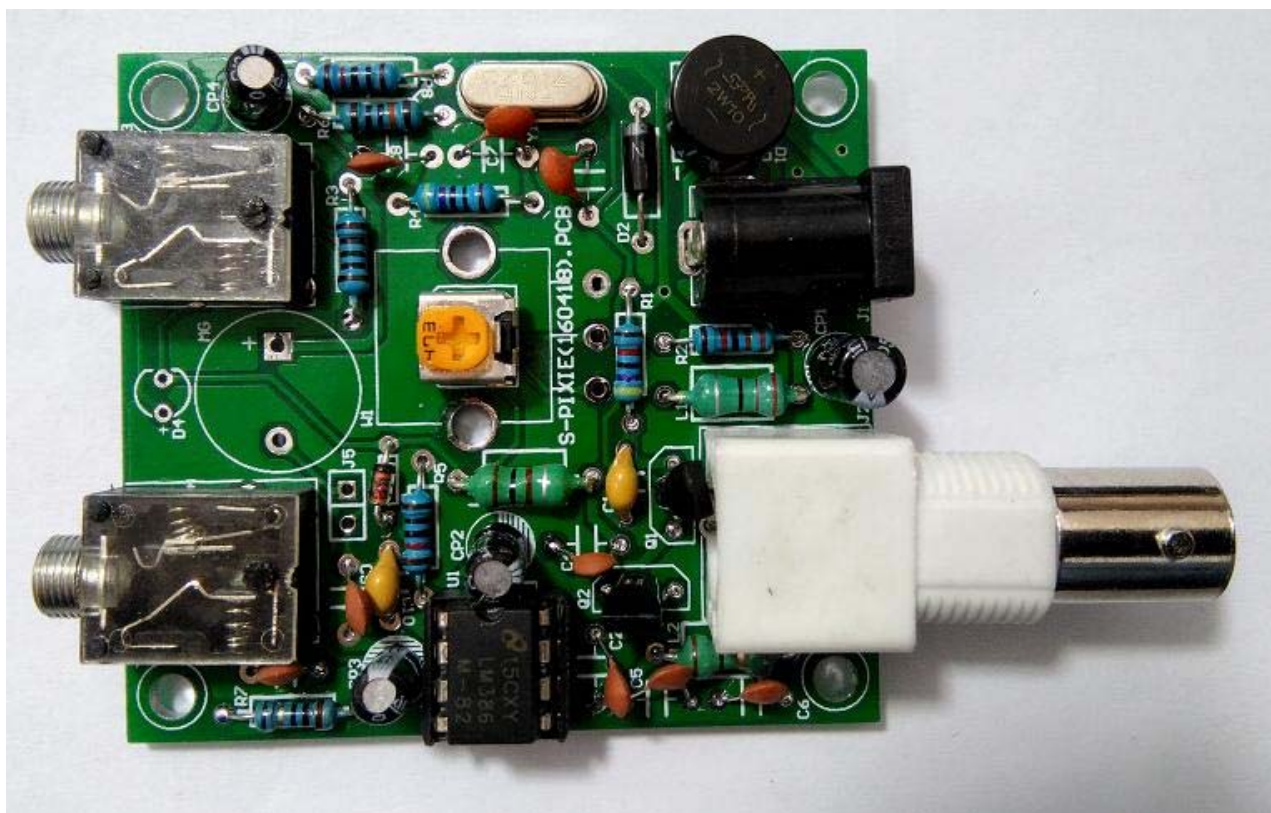
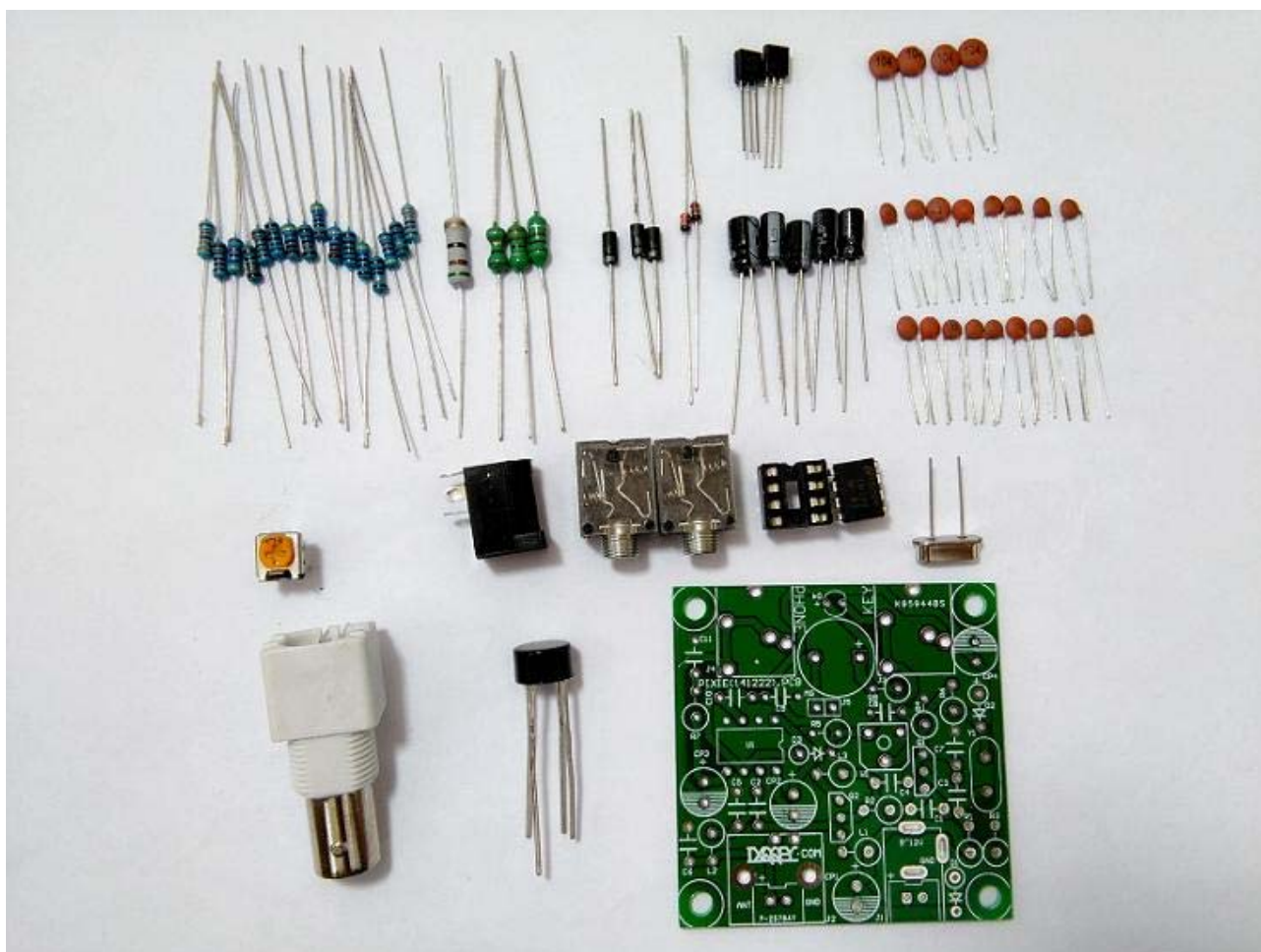

7.4 Q9(BNC), buzzer, LED, small Variable resistor, no Acrylic.

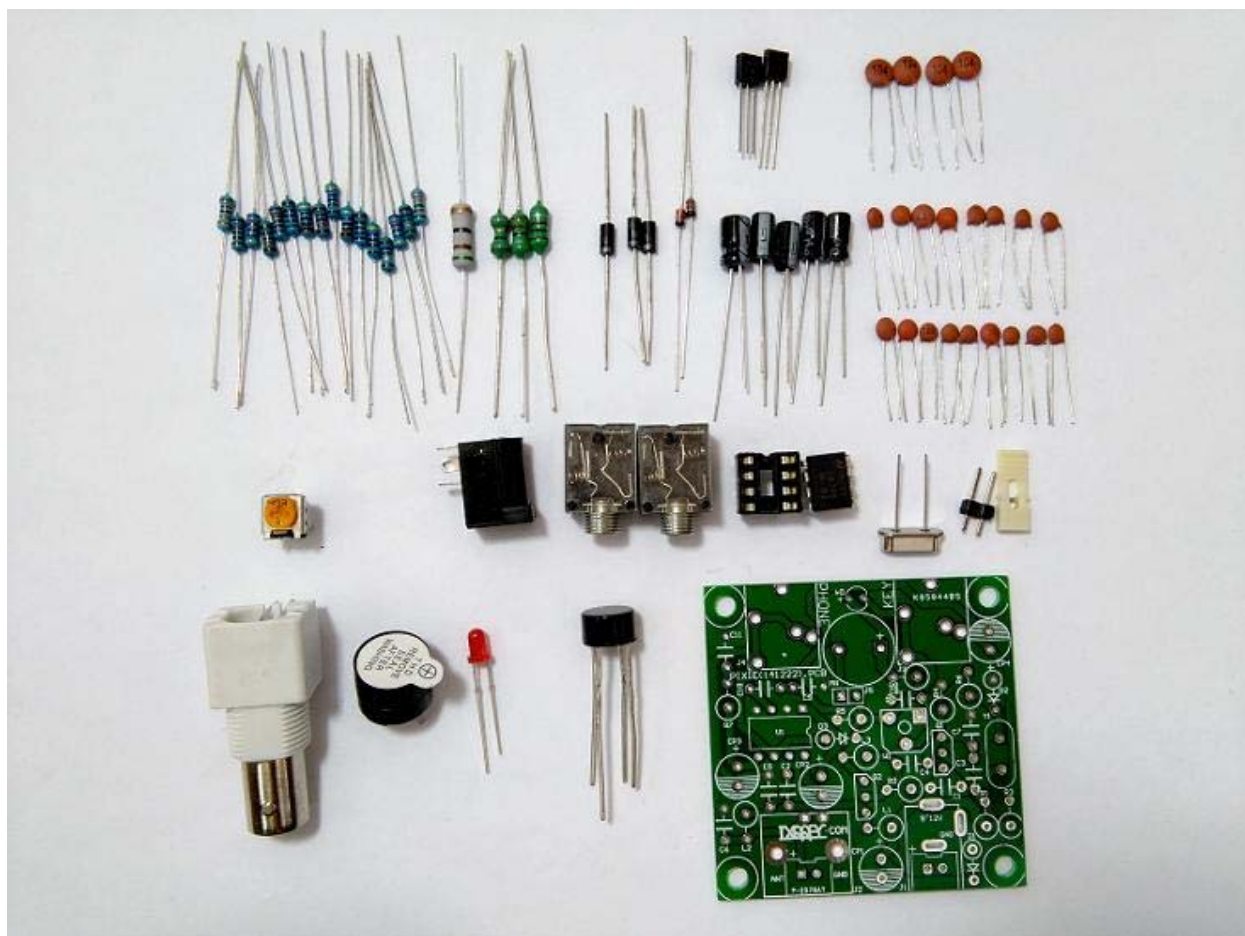

7.5 Q9(BNC), buzzer, LED, big Variable resistor, Acrylic.

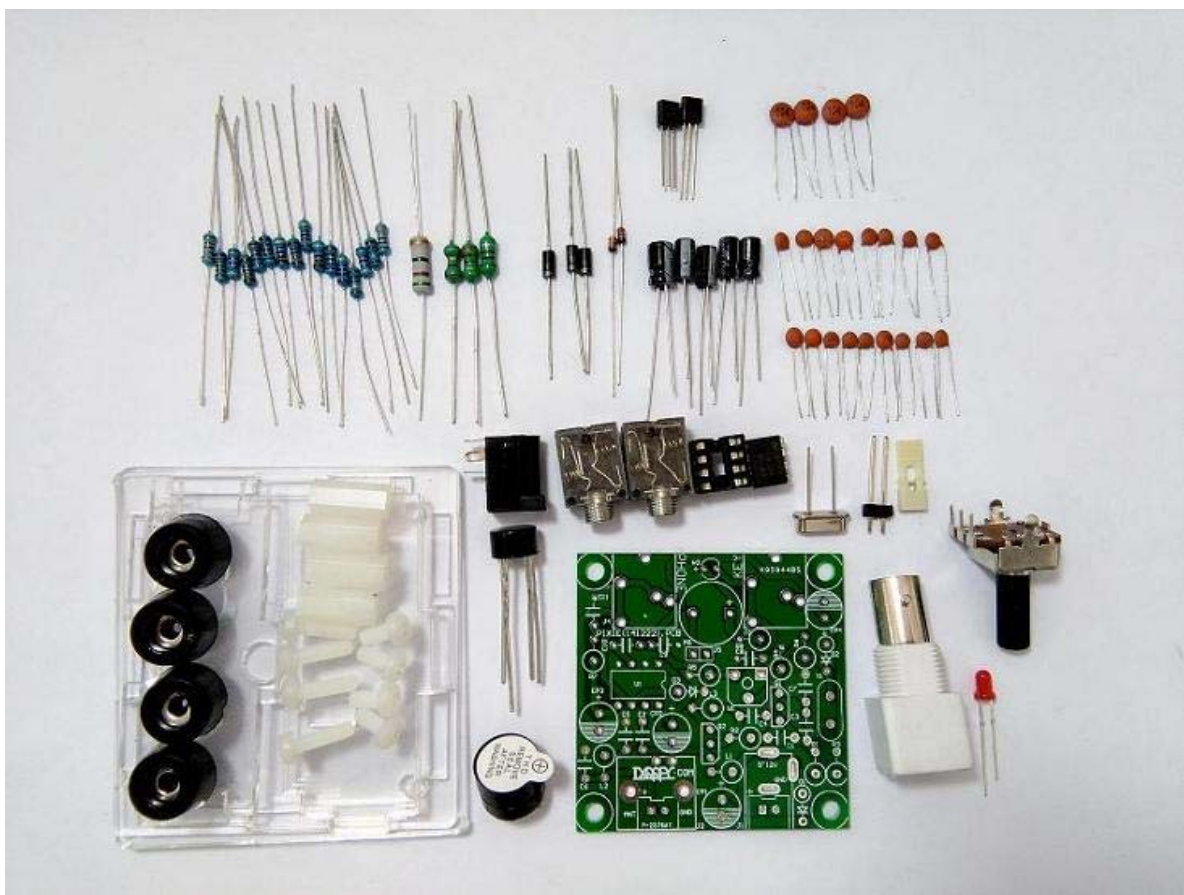

8 List of components

1/4W Resistor		Capacitor	
R7	10 ohm	C1 C10	0.1uF(104)
R4	470 ohm	C2 C4 C8 C11	10nF(103)
R3	1K	C3 C7	100pF(101)
R5 R8	10K	C5 C6	470pF(471)
R2	33K	C9	47nF (473)
R1	47K	Inductance	
R6	100K	L1	22uH(Color ring inductance)
Electrolytic capacitor		L2	1uH(Color ring inductance)
CP1	100uF/16V	L3	100uH (Color ring inductance)
CP2 CP3 CP4	10uF/16V	IC	
Transistor		U1	LM386
D1	2W10(Bridge rectifier)	Crystal oscillator	
D2	1N4001(Diode)	Y1	7.023MHz
Q1	9018(Triode)	Variable resistor	
Q2	8050(Triode)	W1	47K(473)
D3	1N4148(Diode)	Other	
D4	LED	J1	DC Jack
		J2	Q9(BNC)
51ohm 1W Resistor(for dummy load)		J3 J4	3.5mm Socket(Key and Phone)
PCB * 1		J5	Pin and Jumper Cap
Acrylic case		MG	Buzzer

