

VITUS Lite

QUICK START GUIDE V1.1

May. 15th, 2017

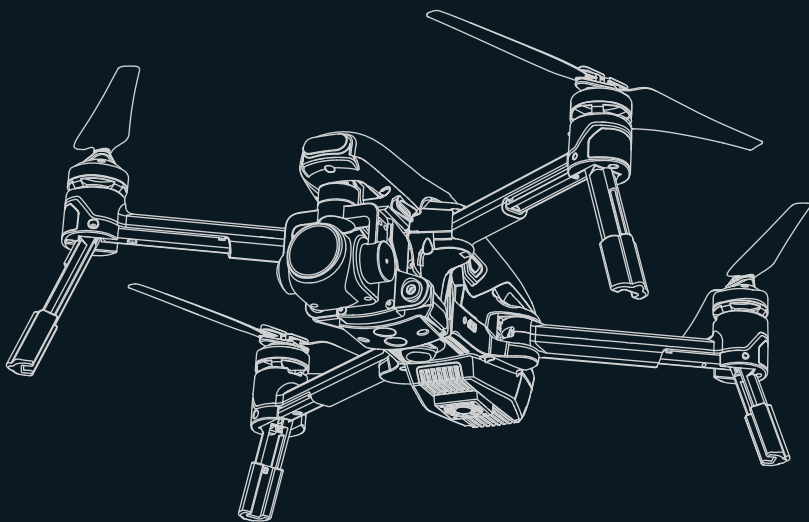

Contents

1.0 Get to know your aircraft	3
2.0 Get to know your remote controller	4
3.0 Specifications	5
4.0 Attention before flight	6
5.0 Charging	6
6.0 Downloading/Installing Game App Walkera GO & Operation App Walkera Drone	6
7.0 Walkera Drone Operating Main Interface Instructions	7
8.0 Walkera GO Main Interface Instruction	8
9.0 Prepare Aircraft	8
10.0 Prepare Remote Controller	9
11.0 Read for Flight	9
11.1 Aircraft Starting/Code-matching	9
11.2 APP Connection	9-10
11.3 GPS Indicator Lights	10
11.4 Motor Unlock/Lock	10
12.0 Flight Control	11-15
13.0 End flight	15
14.0 Additional Instruction	16
14.1 Compass Calibration	16
14.2 Brushless ESC and Brushless Motor connection diagram	16
14.3 Stick Mode Switch, Stick Calibration & Fixed ID	17
15.0 Instruction of Intelligent flight battery Safety	18
16.0 In the Box / List of Articles	19

1.0 Get to know your aircraft

- Foldable design is employed to greatly improve compactness without compromising quality and function.
- More accurate and safe flight is achieved using GPS/GLONASS dual-satellite positioning & navigation system.
- 5.8G WiFi digital video transmission system is used.
- Integrated gimbal camera is capable of shooting stable 4K high-definition videos.

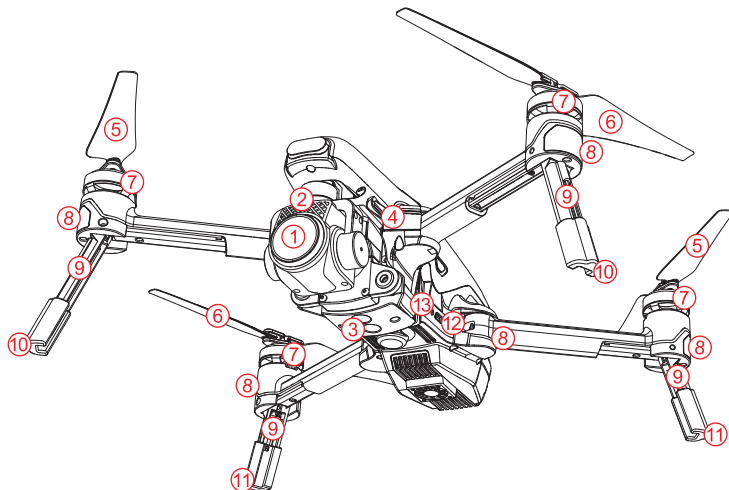

- | | |
|-------------------------------|------------------------------|
| 1. Gimbal and Camera | 9. Landing gear |
| 2. Camera fixture | 10. Stand cushion(A) |
| (Please remove before flight) | 11. Stand cushion(B) |
| 3. Infrared | 12. Upgrade port (Micro USB) |
| 4. Micro SD card slot | 13. Reset key |
| 5. CCW propeller(↺) | 14. Power button |
| 6. CW propeller(↻) | 15. Battery level indicators |
| 7. Brushless motor | 16. Smart flight battery |
| 8. Indicator | 17. Status indicator |

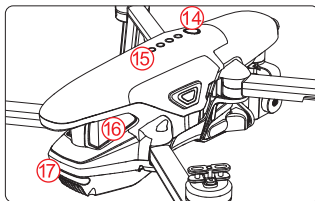

* 1) Maximum time for flight in an experimental environment is 28minutes subject to real conditions.

2) To avoid property loss and personal injury caused by wrong operation, please read the manual carefully and watch the tutorial video at www.walkera.com before using VITUS.

2.0 Get to know your remote controller

DEVO F8S is in-built with a ground receiving terminal of 5.8G WiFi digital video transmission system, which can achieve a real-time display of high-definition images on a mobile device by using Walkera Drone APP, with a foldable holder capable of holding mobile devices.

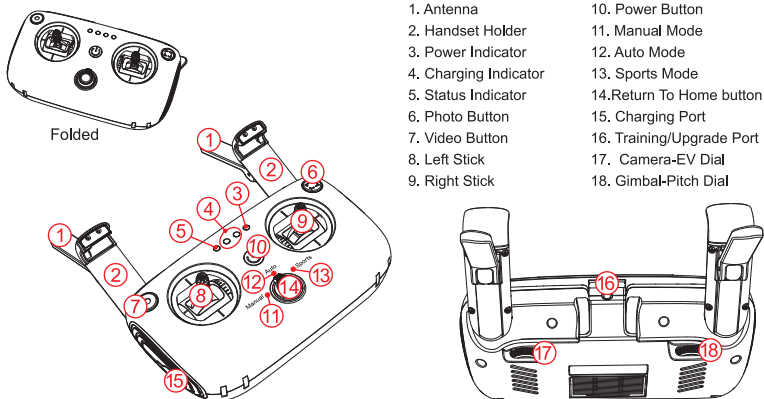

Take “left-hand throttle (MODE 2)” as an example. The left rocker controls the aircraft’s altitude and heading, while the right rocker controls its forward, backward, left and right movements.

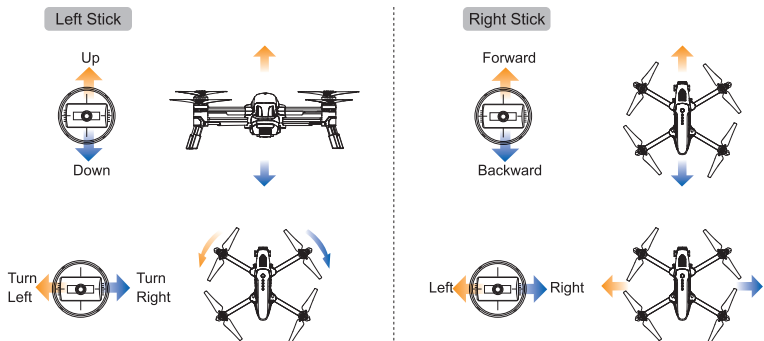

- * 1) MODE 2 (Throttle stick on the left): Left stick–THRO/RUDD; Right stick –ELEV/AILE.
- 2) MODE 1 (Throttle stick on the right): Left stick–ELEV/RUDD; Right stick–THRO/AILE.
- 3) Maximum communication distance in an experimental environment is 1500 meters subject to real conditions.

3.0 Specifications

• Aircraft

Main Rotor Dia.:	177mm
Dimensions (L x W x H):	229 x 279 x 113mm
Weight:	870g(batteries included)
Remote Controller:	DEVO F8S
Main board:	VITUS 320
Brushless Motor:	WK-WS-28-017A
Brushless ESC:	VITUS 320
Battery:	11.4V 5200mAh LiPo 3S
Flight Time:	25minutes for positioning flight (with 10% battery level residual) 28minutes for ultimate flight
Working temperature:	-10°C ~ +40°C

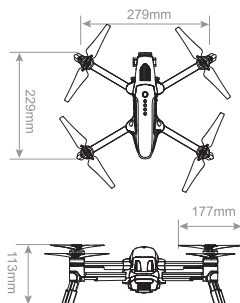

• Gimbal

Controllable turn range:	-90°~ 0° pitch
--------------------------	----------------

• Camera

Image Sensor:	SONY: 1/2.3" CMOS; pixel 12MP
Lens:	FOV 85° ; 4.4mm; f/2.8 aperture
ISO Scope:	100-12800
E-shutter:	1/30-1/8000
Photo resolution:	4000x3000(12MP) 3840x2160(8MP)
Record resolution:	UHD: 3840x2160(4k) 30fps FHD: 1920x1080 30fps/60fps
Max. code rate of video storage:	64Mbit/s
Supported file system & format:	Fat32; exFat
Picture format:	JPEG
Video format:	MP4
Memory card supported:	Micro SD card , max. 64G

• DEVO F8S remote controller

Dimensions (L x W x H):	173 x 101 x 71mm
Working frequency:	2.4G
Signal range:	About 1.5KM (open without shelter, no electromagnetic interference)
Built-in battery:	7.4V 2200mAh Li-po 2S

4.0 Attention before flight

- 1) The VITUS is intended for pilots, 14 years or older, with RC hobby experience.
 - 2) Please do not fly in severe weather conditions, such as rainy, snowy, windy or foggy conditions.
 - 3) Always choose large open fields for flying, the densely constructed buildings may affect compass, shelter GPS signal and deteriorate positioning effect of aircraft, and even lead to inability to position it.
 - 4) Please keep the flying aircraft away from high-speed rotating parts (such as propeller or brushless motor).
 - 5) Always keep the aircraft within sight, and keep it away from obstacles, crowds and water.
 - 6) Do not fly close to high-voltage power lines, cellphone towers, or radio towers, as these may disrupt your control signal.
 - 7) Always check local laws before flying, and never violate local laws or ordinances concerning legal flying areas.
 - 8) When aircraft flying above 4500 meters, flight performance may be undermined because of decreased performance of battery and gravity system.
-

5.0 Charging

- 1) Connect charger to AC power (100-240V 50/60HZ).
- 2) Please charge under the condition of the closed power for remote controller and smart flight.
- 3) Smart-flight battery level indicator light remains off indicates battery fully charged; while remote-controller charging indicator green light steady on indicates battery fully charged.

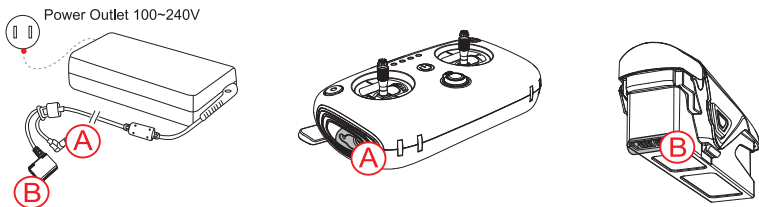

6.0 Downloading/Installing Game App Walkera GO & Operation App Walkera Drone

Please go to Walkera Official website (www.walkera.com) or Google Play to download/install it for Android system.

Please download/install it from App Store for iOS system.

To obtain best experience, tablet devices are recommended to run this software,

which supports **iOS 9.0 / Android 5.0** or above.

7.0 Walkera Drone Operating Main Interface Instructions

on the interface, HD video and photographs can be previewed in realtime, as well as the dynamic parameters, such as aircraft, remote controller, gimbal and battery.

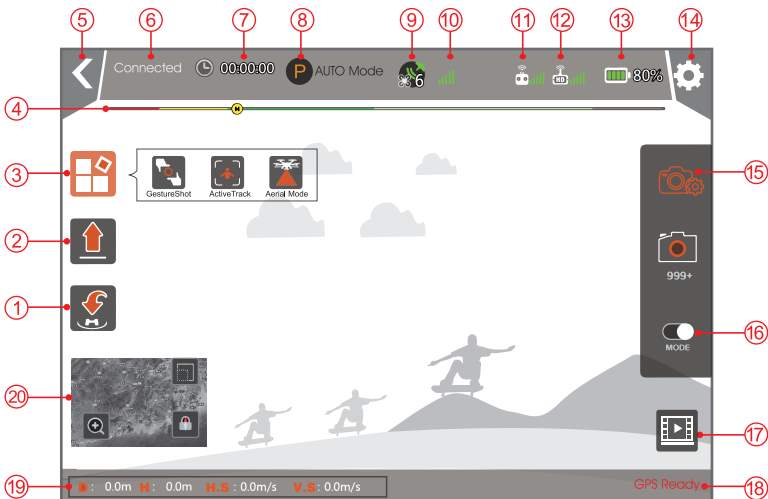

1. Return Home [🏠]: Click it, the aircraft stops waypoints flying, and return back automatically.
2. Auto Takeoff [📈]: Click it, the aircraft takes off automatically.
3. Function box [📁]: Gesture shot, Active Track, and Aerial Modes.
4. Battery level return [🔋]: When the residual battery level reach **H**, aircraft will automatically return back.
5. Return [<]: Return to last step.
6. Device connection status: Display connected or disconnected.
7. Flight time [⌚]: Aircraft flight time
8. The aircraft model: Display aircraft flight mode,
9. Number of aircraft satellite [📶]: Displays the received satellites of aircraft,
10. Positioning accuracy [📶]: Displays aircraft positioning accuracy,
11. Remote controller signal strength [📶]: Displays the signal level between remote controller and aircraft.
12. Transmission signal strength [📶]
13. Battery level [🔋 80%]: Real-time display of current smart flight battery remaining level (voltage customizable)
14. Setting [⚙️]: Click the icon to open the setting menu to perform general settings, settings for aircraft, remote controller, gimbal & battery
15. Camera setting [📷]: Click the icon to show professional, image, video and other settings. Under the same resolution, the higher the code rate is, the better the image quality is, and the video transmission distance can be accordingly reduced.

16. Photo & video switch [📷]:
Photo: Photo button is used to trigger the camera to take pictures. While this function is also supported in the remote controller.
Video: video button to start/stop video, You can also press the video button on the remote controller for video.
17. Video display [📺]
18. GPS positioning status: When connected, "GPS positioning" appears; when disconnected, "GPS not positioning" appears.
19. Flight status parameters:
Distance: horizontal distance of aircraft with returning point,
Height: vertical distance of aircraft with returning point,
Horizontal speed: speed of aircraft in a horizontal direction,
Vertical speed: speed of aircraft in the vertical direction,

20. A thumbnail map icon:

Click the thumbnail icon to quickly switch to the map interface,

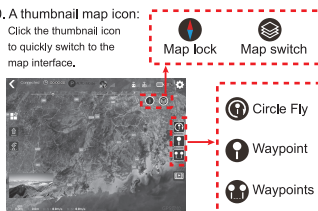

8.0 Walkera GO Main Interface Instruction

The Walkera GO will be activated once you start the Aircraft Auto with a strong GPS signal.



1. FPV simulation mode: Just connecting remote controller with your cellphone, you can enjoy a flight experience simulating a real scene.
2. MR games: With virtual reality combined with game, it has 3 game modes including racing, collection & battle.
 - Racing Mode: Click to enter Racing mode. You can set up a virtual circuit in a real scene, practice the racing flight, and improve your flight skills.
 - Collection Mode: Click to enter Collection mode. You can follow a prescribed route to collect COINS, and win rewards after completing the game.
 - Combatting Mode: Click to enter Battle Mode. Enemy aircrafts around you, press fire and shoot down enemy planes to win the game.
3. Aerial mode: Simple aerial photo mode, photography & video.

9.0 Prepare Aircraft

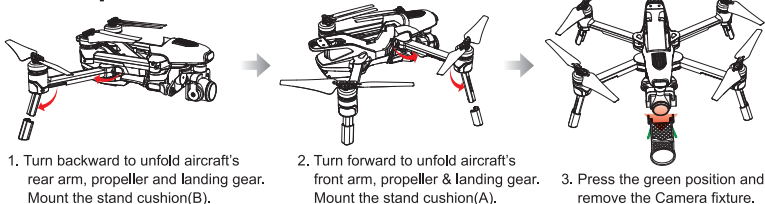

Attention:

- Be sure to unfold rear arm before unfold front arm. Start aircraft after arm, propeller and camera mount are fully unfolded.

10.0 Prepare Remote Controller

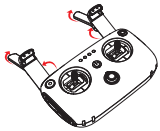

1. Unfold antenna & mobile device holder.

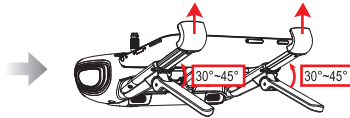

2. Pull upward mobile device holder, place a cellphone and clamp it. Adjust antenna & mobile device holder, make their included angle between 30°~45°.

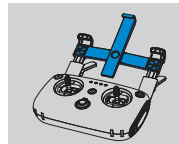

Mount the tablet support, maximum size can be up to 8.0".

11.0 Read for Flight

Place the aircraft in an open outdoor area, with its tail facing the operator.

11.1 Aircraft Starting/Code-matching

- ① Insert the battery.
- ② Start remote controller and smart flight battery.
- ③ Place aircraft at horizontal position, **right red LED light flashing until steady on indicates completion of IMU prewarming & code-matching.**

(Right/left red LED lights alternatively flashing indicates aircraft being abnormal, see also APP tips.)

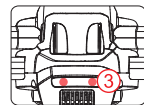
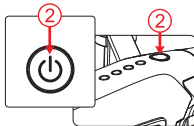
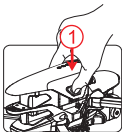

- ④ Open the Mobile Wi-Fi device, wait for 30 seconds, when at the same time appear "Vitus-Ground-****" and "Vitus-Air-****", click "Vitus-Ground-****", input password "1234567890" to connect and exit settings after a successful connection.

11.2 APP Connection

Connecting operation app. Walkera Drone



1. Click the icon on cellphone.

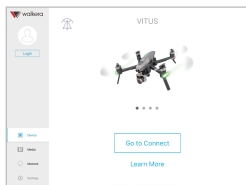

2. Choose aircraft VITUS, touch "Go to connect".

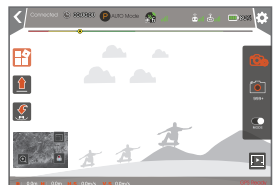

3. Enter main interface.

Connect game software Walkera GO



Walkera GO

1. Click the icon on mobile device



2. Connecting



3. Enter main interface



Attention:

- Walkera GO & Walkera Drone cannot be simultaneously used on the same mobile device, you can use another APP only when an App is exited.

11.3 GPS Indicator Lights

When the left red LED light slowly flashes, the GPS function works.

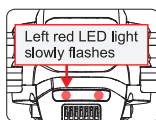

11.4 Motor Unlock/Lock

Motor Unlock

After successful code-matching, move the left & right sticks down and toggle them outward, and hold for 1.5 seconds. You will see **the right red LED light flashes**, indicating that motors are unlocked. The unlocked motors will rotate, and immediately release sticks.

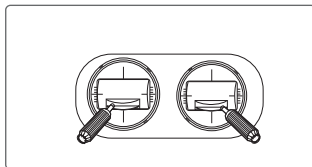

Motor Lock

There are two methods to lock the motors:

Method 1: When the aircraft is landed, push and hold the throttle stick down. The motors will stop after 2 seconds.

Method2: Move the left and right stick down while toggle them outward and hold for 2 seconds.

You will see **the right red LED light always on**, indicating that motors are locked.

Method 1



Method 2

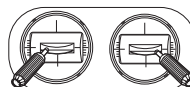

12.0 Flight Control

- 1) Make sure that the GPS signal is received (left red LED light blinks).
- 2) Only when “Connected” displays on the status indicator column above the Walkera Drone APP, you can perform APP operation.
- 3) Please unlock motors before takeoff. (refer to Page 10 for the detailed method)

AUTO takeoff (APP operation)



Click this icon on APP main interface, the aircraft will take off automatically.

Attention:

- 1) Auto Takeoff is usable only under AUTO mode or Motion mode.
- 2) Auto takeoff default to 3m altitude, and it can be removed by pushing the throttle to midpoint or above, whenever manual control over the throttle is needed.

Auto Landing(APP operation)



Click this icon on APP main interface, the aircraft will land automatically.

Attention:

- 1) During landing, you can operate the aircraft forward, backward, rightward and leftward.
- 2) During the landing process, please switch the flight mode of the remote controller if landing needs to be cancelled.

AUTO Mode (Remote controller operation)



Switch to “Auto” position

Attention:

- 1) After charging each time, the first flight is default to AUTO mode.
- 2) In the AUTO mode, there are Altitude Hold, Fixed Point, and Brake Function, the flight speed is slower ($\leq 5\text{m/s}$).
- 3) When GPS signal is weak or disappearing, only Altitude hold rather than Fixed point is available.
- 4) No fixed point available in the Manual mode.

Sports Mode (Remote controller operation)

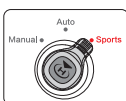

Switch to “Sports” position

Attention:

- 1) In the Sports mode, there are Altitude Hold, Fixed Point, and Brake Function, the flight speed is faster ($\leq 10\text{m/s}$).
- 2) When GPS signal is weak or disappearing, only Altitude Hold rather than Fixed Point is available.
- 3) No Fixed Point available in the Manual mode.

Return to Home (Remote controller or APP operation)



Click this icon on the APP interface, the aircraft will return automatically.



Short press , the aircraft will return automatically.

Horizontal distance between aircraft & Home point > 30m

- a. When the flight altitude is over RTL Height, the aircraft will keep the current altitude and return above the Home Point, then descend vertically.
- b. When the flight altitude is under RTL Height, the aircraft will elevate to 25m high, then fly back above the HP, and descend vertically.

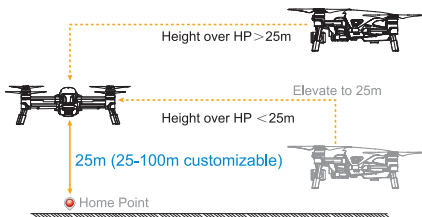

Horizontal distance between aircraft & Home point < 30m

- a. When the flight altitude is over RTL Height, the aircraft will keep the current altitude and return above the Home Point, then descend vertically.
- b. When the flight altitude is under RTL Height, the aircraft will keep the current altitude and return above the Home Point, then descend vertically.

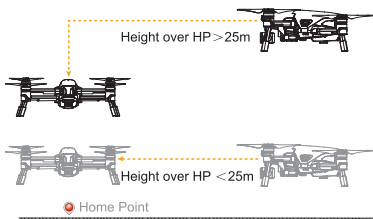

Attention:

- 1) To enter one key return, please don't move other switches and buttons.
- 2) When the aircraft loses the remote controller signals, it will automatically enter Failsafe RTH.
- 3) When aircraft battery voltage is too low, and aircraft with Home point horizontal distance is greater than 30m, the aircraft will automatically return back. When the aircraft with Home point horizontal distance is less than 30m, the aircraft will return automatically from the current position and land.
- 4) When GPS signal is abnormal or GPS not working, Auto return is unusable, but auto landing usable.
- 5) During the returning home process, please switch the flight mode of the remote controller if returning home needs to be cancelled.

Active Track Mode (APP operation)

There are two modes: **Lock Mode** & **Follow Mode**

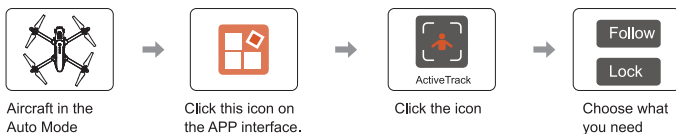

Lock Mode: aircraft position unchanged, heading lock the target to be followed.

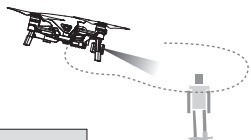

Follow Mode: aircraft position & heading lock the target to be followed.

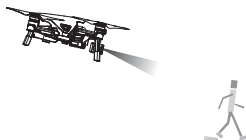

Attention:

In the Follow mode, the aircraft is kept at a constant altitude, care must be taken to the flight surrounding and assure you or others of personal and property security.

Gesture Shot (APP operation)

Please follow these steps to use the **Gesture Shot** function.

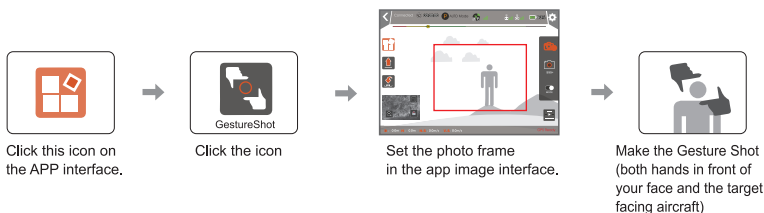

Attention: Gesture Shot is valid only in the shot mode. The UAV should be 2m away to recognize you.

Aerial Mode (APP operation)

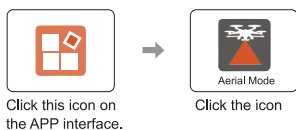

Circle Flight (APP operation)

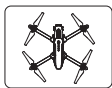

Aircraft in the Auto Mode

Click the icon on the APP map interface, the aircraft enters the circle flight mode.



Attention:

- 1) The aircraft is at a quiescent state when it enters auto-circling, the circling function can only work after you set circle speed and direction by **toggleing aileron stick left or right** (-5m/s to +5m/s speed changeable, 0m/s at default).
- 2) **Dial elevator stick up or down** to change circle radius (5~50m radius changeable, 5m at default)

Dial to the left
Clockwise circles



Dial to the right,
Counterclockwise circles.

Speed: the larger volatility toggling and longer holding time, the faster circling. The slower on the contrary.

Dial up, Circle radius turns small



Dial down, Circle radius turns large

Waypoint Flight (APP map interface operation)

Click the icon  to enter the Waypoint Flight interface.

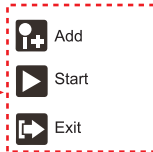
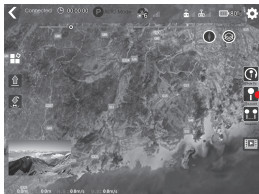

Waypoints (APP map interface operation)

Click the icon  to enter the Waypoints Flight interface.

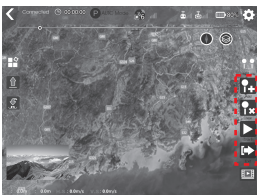
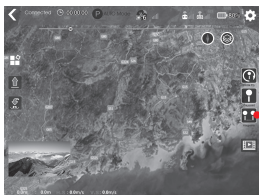
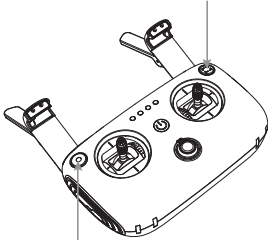

Photo & Video (Remote Controller or APP operation)

Remote Controller Operation:

Take photo by short pressing the button of Remote Controller



Video by short pressing the button of Remote Controller

APP Operation:

- 1) Choose working mode: photo or video
- 2) Touch the Photo or video icon to take photo or video

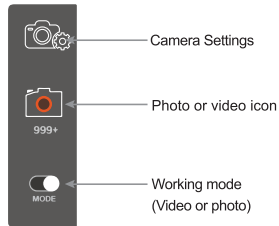

Gimbal Control (Remote Controller or APP operation)

The integrated gimbal provides camera with a stable platform, making the camera capable of obtaining stable pictures even under the condition of aircraft flying at a high speed.

You can use the APP software or Gimbal-Pitch Dial on Remote Controller to control the gimbal pitching.



Gimbal-Pitch Dial
Toggle left or right



Slide upward or downward
on the APP image interface.

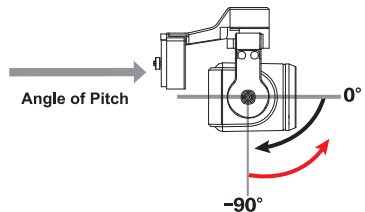

13.0 End flight

- ① Manual landing or return to home function landing.
- ② Power off the aircraft, then turn off remote controller.
- ③ Finally, remove the battery from the aircraft.

14.0 Additional Instruction

14.1 Compass Calibration

 Attention:

- Calibrate compass when circle flight or skewing occurs during flight (motor locked, light red LED remains on).
- Please conduct calibration in an open outdoor area away from electromagnetic interference.

The compass calibration steps are as follows:

① Place right/left sticks at lowest location, toggle them inward and keep for 5 seconds the aircraft Left red LED light extinguishes, Right red LED light flashes.

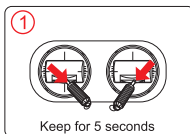

② Horizontal 360° rotation of aircraft until left red LED light steady on, right red LED light flashes.

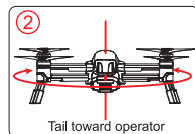

③ Vertical 360° rotation of aircraft (heading down) until right/left red light ready on, indicating successful calibration, and place aircraft at a horizontal location. In case of failure to calibrate, please follow above procedure to repeat calibration.

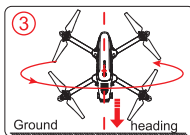

14.2 Brushless ESC and Brushless Motor connection diagram

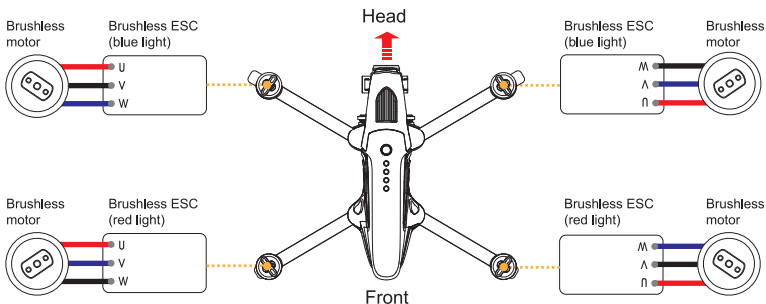

 Attention:

- The red, blue and black wires of the brushless motors must be soldering to the brushless ESC according to the illustration.

14.3 Stick Mode Switch, Stick Calibration & Fixed ID



Tip:

- Factory setting of DEVO F8S stick mode & stick calibration has been determined; please refer to the following operation method for switching and calibration.
- Be sure to switch off the aircraft power or lock motor before operation.

Stick Mode Switch:

Enter stick Mode switch	1. Left stick at the lowest position + Long press 3-5 sec> When beeps, enter the stick mode switch
	2. Release left stick (back middle) + Short press > Choose MODE 1, MODE 2, MODE 3, MODE 4
Exit stick Mode switch	1. Left stick at the highest position + Long press 3-5 sec> When beeps, confirm and exit the stick mode switch.

MODE 2 & MODE 4 are left-hand throttle

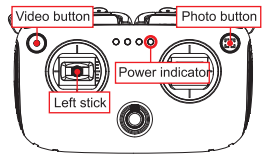
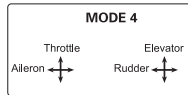
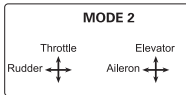

MODE 1 & MODE 3 are right-hand throttle

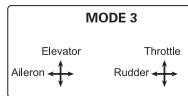
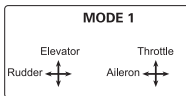

Indicators react according to the stick mode

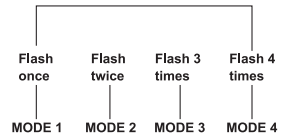

※ Customization also supported in Walkera Drone APP.

Stick Calibration:

Long press " " for 3-5 sec, you will hear a beep. Enter stick calibration, repeatedly move sticks from minimum to maximum mechanical range for several times, and then back to the middle.
 Long press " " for 3-5 sec, when beeps, confirm and exit the stick calibration.



Attention:

- Beeping when you exit, indicating calibration fails, please recalibrate.

Customized Fixed ID of DEVO F8S:

Long press " " for 3-5 sec, when beeps, Fixed ID is set.
 Short press " ", when beeps, Fixed ID is cleared.

15.0 Instruction of Intelligent flight battery Safety



Attention:

- Intelligent flight battery must be placed at a well-ventilated place.
- Improper use, charging or storage of battery may lead to fire accident, property loss or personal injury. The following safety guideline for use of battery must be followed.

15.1 Use of Battery

- 1) Battery is prevented from contacting with any liquid, and battery being moisturized or immersed into water is also inhibited. Never use it in rain or a wet condition. When internally contacting with water, battery may decompose, auto-ignite or explode.
- 2) Only batteries supplied by Walkera can be used. In case of replacement, please go to Walkera official website for the purchase information. Walkera will not be responsible for any flight failure or other accidents, which are resulted from use of other batteries than supplied by Walkera.
- 3) Use of any bulged, leaked batteries or those with damaged package is inhibited. In case of any happening, contact Walkera or one of its authorized dealers for professional treatment.
- 4) Please switch power off before batteries are inserted into or removed from the aircraft. Never insert or remove batteries when their power are switched on, otherwise power port may be damaged.
- 5) Its working temperature between $-10\text{ }^{\circ}\text{C}$ ~ $40\text{ }^{\circ}\text{C}$ must be kept; excessive high temperature (above $50\text{ }^{\circ}\text{C}$) may cause fire or explosion, while excessive low temperature (under $-10\text{ }^{\circ}\text{C}$) may shorten its service life.
- 6) Never use battery in an electrostatic or magnetic field, otherwise battery pack may malfunction and lead to severe aircraft failure.
- 7) It is not permitted to decompose by any means or puncture battery using any sharp object, otherwise fire accident or explosion may be caused.
- 8) Be sure to keep away from any battery where leaks the highly corrosive liquid. Please use clear water to rinse skin or eyes contacting with corrosive liquid for at least 15 minutes, and seek for medical service when necessary.
- 9) The battery which has been fallen off from aircraft or impacted by external force must be not reused.
- 10) When any battery drops into water by accident during aircraft flying or in other situation, battery must be immediately removed and placed in an open field, operator shall keep away from battery until it is aired dry. However, those air-dry batteries cannot be reused, and must be disposed of properly.
- 11) Never place battery into a microwave oven or pressure cooker.
- 12) Never place battery cell onto any conductor surface.
- 13) Never short circuit battery using a wire or other metal object.
- 14) Never hit against battery, and never place any heavy object onto battery or its charger.
- 15) Use a dry cloth to remove any dirt on battery connector, otherwise any improper contact may result in loss of energy or charging failure.

15.2 Battery Maintenance

- 1) Never overcharge battery, otherwise battery cell may be damaged.
- 2) Never use charger in an excessive high or low temperature.
- 3) Keeping battery idle for a long time may undermine its performance.

16.0 In the Box / List of Articles

Check all the following items in your package. If any of them is missing, please contact walkera or your local dealer.

Aircraft x1



Remote Controller x1



Propellers (Pair) x2

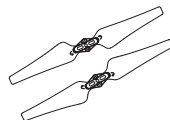

Aircraft Battery x1

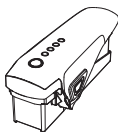

Charger x1

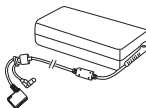

Power Cable x1

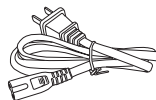

Micro-USB Cable x1

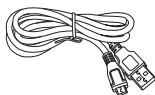

Stand cushion A/B x2

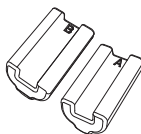

Tool Kit x1



Manuals x1

«QUICK START GUIDE»





Manufacturer: Guangzhou Walkera Technology Co.,Ltd.

Add: No.48 Wantai Rd, Taishi Industrial Park, Dongchong Town,
Nansha Dist, Guangzhou, China.511453

Hotline: 400-931-8878

User manual is subject to change
without prior notice.
Please go to Walkera official website
to get the latest version.

